

2" wide aperture LED luminaire with flush lens, wood or steel cladding

Project: _____ Type: _____

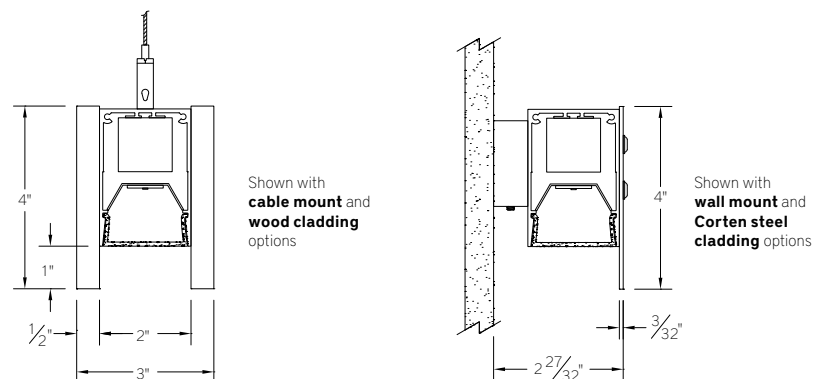

SECTION



PERFORMANCE

NOMINAL LENGTH	OUTPUT	LUMENS/ft.	WATTS/ft.	LUMINAIRE LUMENS	EFFICACY (LPW)
4'	L: low	315	4.5	1795	69
	R: regular	405	7.4	1573	55

Note: All data reflects fixtures with 3500K LEDs.

FEATURES

The REAL80 is a linear directional LED luminaire for general lighting applications. The 2" wide by 3" tall aluminum extruded housing is clad with 1/2" thick wood planks or heavy gauge Corten steel. The furniture grade wood options are available in several standard varieties, with hand applied finishes, while the Corten steel is clear coated. The REAL80 is available for cable or wall mounting and offered with a variety of dimming driver and light color options for added versatility. The REAL80 is Controls Capable, being offered with a variety of integrated control options.

SPECIFICATIONS

Fixture constructed of an extruded aluminum housing, extruded, frosted acrylic lens, machined aluminum end caps and wood or steel cladding.

Model variations offered for cable suspended and wall mount applications.

Standard housing and end cap finishes as shown below.

Wood side cladding is 1/2" thick, furniture grade, in solid walnut, European beech, mahogany, white oak and bamboo ply or nine-ply Baltic birch with maple face.

Solid wood planks and bamboo ply are hand finished in five to seven coats of clear shellac and sealed with clear liquid wax for a natural look and easy cleaning.

Baltic birch planks are available with a clear shellac finish or water-based stain with clear sealer.

Corten steel side cladding is 14 gauge with matte clear powder coat finish and includes button head fasteners in black finish.

Optional decorative industrial hardware with black finish available for wood cladding.

Fixtures available in nominal lengths of 2'-8'.

Standard integral 120-277V driver offered with 0-10V dimming or non-dim (other dimming driver options available).

Integral 120-277V emergency battery backup available for 6' or 8' nominal, single circuit fixtures with non-dim or 0-10V dimming (consult factory for all other lengths/drivers).

Standard light outputs are 315 and 405 lumens per foot.

LEDs available in 2700K, 3000K, 3500K and 4000K, within a 3 step MacAdam ellipse, all with 90+ CRI typical.

Flat blade louver option available.

Bartco Lighting Controls Capable fixture available with integrated controls from a variety of suppliers.

Life: 50,000 hours L₇₀.

Limited five year warranty

UL and C-UL listed for dry locations



2" wide aperture LED luminaire with flush lens, wood or steel cladding

REAL80 -



<p>O.A. FIXTURE LENGTH*</p> <p>2: 24-5/8"</p> <p>3: 35-5/8"</p> <p>4: 46-5/8"</p> <p>5: 57-5/8"</p> <p>6: 68-5/8"</p> <p>7: 79-5/8"</p> <p>8: 90-5/8"</p>		<p>DRIVER</p> <p>ND: non-dimming [Dimming]</p> <p>D: 0-10V, 1%</p> <p>DTR: triac, 1%, (120V ONLY)</p> <p>DLV: electronic low voltage, 1%, (120V ONLY)</p> <p>HES: Lutron EcoSystem, soft-on/fade-to-black, 1%</p> <p>EL: eldoLED ECOdrive 0-10V, 1%</p> <p>ES: eldoLED SOLOdrive 0-10V, 0.1%</p> <p>ELD: eldoLED ECOdrive DALI, 1%</p> <p>ESD: eldoLED SOLOdrive DALI, 0.1%</p>	<p>LIGHT OUTPUT (lumens per foot)</p> <p>L: low – 315</p> <p>R: regular – 405</p> <p>CF: consult factory for custom output</p>	<p>MOUNT</p> <p>WD: wall mount – direct</p> <p>WI: wall mount – indirect</p> <p>C4: cable mount 4' cable length</p> <p>C8: cable mount 8' cable length</p>	<p>OPTIONS</p> <p>ED: emergency driver (6' or 8' non-dim or 0-10V only)</p> <p>L: louver</p> <p>DH1: deco. hardware – flanged button head *</p> <p>DH2: deco. hardware – flanged hex head *</p> <p>WS1A: Wattstopper FS-205, 100%-0% ‡</p> <p>WS1B: Wattstopper FS-205, 100%-50% ‡</p> <p>EN1: Enlighted FS-D22 ‡</p> <p>ES4: Philips EasySense SNS211 MC ‡</p> <p>CA1: Casambi CBU-A2D ‡</p> <p>NL1: nLight RES7 ‡</p> <p>NL2: nLight RIO ‡</p> <p>LA1: Lutron Athena A-WN-D01-RF-WH ‡</p> <p>LA2: Lutron Athena A-WN-D01-OCC-WH ‡</p>	<p>HOUSING/END CAP FINISH</p> <p>AW: architectural white (semi-matte)</p> <p>WH: white (semi-gloss)</p> <p>BL: black (semi-matte)</p> <p>MB: matte black</p> <p>ESS: environmental satin silver</p> <p>BZ: bronze</p> <p>PR: primer</p> <p>SA: satin anodize (may require additional lead time)</p>	<p>CLADDING FINISH</p> <p>WN: walnut</p> <p>EB: european beech</p> <p>MH: mahogany</p> <p>WO: white oak</p> <p>BB: bamboo</p> <p>P01: Baltic birch - maple</p> <p>P02: Baltic birch - red</p> <p>P03: Baltic birch - orange</p> <p>P04: Baltic birch - green</p> <p>P05: Baltic birch - blue</p> <p>CS: Corten Steel</p> <p>CF: consult factory for custom finish</p>
<p>CORRELATED COLOR TEMPERATURE</p> <p>27: 2700K-90+ CRI</p> <p>30: 3000K-90+ CRI</p> <p>35: 3500K-90+ CRI</p> <p>40: 4000K-90+ CRI</p>				<p>RUN CONFIGURATION</p> <p>SN: single</p>			

* Applies to solid wood and plywood cladding.
‡ See Integrated Controls section for driver compatibility information.

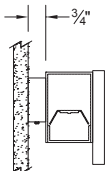
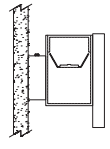
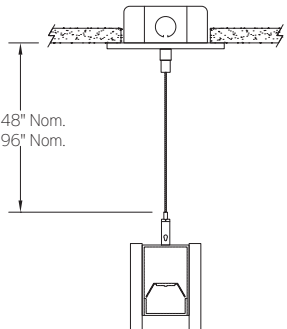
MOUNTING

	ORDERING CODE	DESCRIPTION
	WD	<p>WALL MOUNT – DIRECT ORIENTATION</p> <p>Mounting option includes:</p> <ul style="list-style-type: none"> 1-7/8" H x 4-1/2" W sheet aluminum bracket projects the fixture housing 3/4" from the wall surface. Bracket finish matches fixture finish, or ESS for satin anodize (SA) housing.
	WI	<p>WALL MOUNT – INDIRECT ORIENTATION</p> <p>Mounting option includes:</p> <ul style="list-style-type: none"> 1-7/8" H x 4-1/2" W sheet aluminum bracket projects the fixture housing 3/4" from the wall surface. Bracket finish matches fixture finish, or ESS for satin anodize (SA) housing.
 <p>C4 = 48" Nom. C8 = 96" Nom.</p>	C4 and C8	<p>CABLE MOUNT</p> <p>Mounting option includes:</p> <ul style="list-style-type: none"> Ø 1/16" x 48" (C4) or 96" (C8) aircraft cables 60" (C4) or 108" (C8) power cable (in coordinating finish) Bracket bars Ø 5" white canopies Ceiling couplers Side exit cable grippers

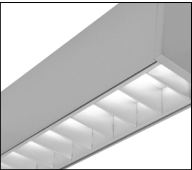





OPTIONS

	ORDERING CODE	DESCRIPTION	SPECIFICATIONS
	ED	EMERGENCY LED DRIVER	<ul style="list-style-type: none"> • Universal 120-277V input voltage emergency driver delivers initial minimum power of 10W for 90 minutes. • Available for 6' or 8' nominal length non-dim or 0-10V fixture only (consult factory for all other lengths/drivers). • Provided with combination test switch/indicator light for remote mount installation.
 <p data-bbox="133 850 337 871">Note: wood sides not shown.</p>	L	LOUVER	<ul style="list-style-type: none"> • 2" W Flat blade louver with 5/8" blades at 7/8" spacing, formed from sheet steel. • Finish is Environmental Satin Silver (consult factory for alternate finishes). • Supplied with light diffusion film.
	DH1	DECORATIVE HARDWARE – FLANGED BUTTON HEAD	<ul style="list-style-type: none"> • Flanged button head decorative industrial hardware in black oxide finish. • For solid wood and plywood cladding only.
	DH2	DECORATIVE HARDWARE – FLANGED HEX HEAD	<ul style="list-style-type: none"> • Flanged hex head decorative industrial hardware in black phosphate finish. • For solid wood and plywood cladding only.

OPTIONS - INTEGRATED CONTROLS

Note: Control option takes up 4" of the overall lens length.
Controls are mounted to flush filler piece.



	ORDERING CODE	LIGHT OUTPUT SETTING	MODEL	CONTROL PROTOCOL	FUNCTIONS	COMPATIBLE DRIVERS
 legrand WATTSTOPPER®	WS1A	100% - 0% ¹	FS-205	N/A	PIR occupancy and light level sensor.	For use with on/off or 0-10V dimming drivers only.
	WS1B	100% - 50% ¹				
 Enlighted	EN1	Set during commissioning	FS-D22	Bluetooth Wireless	PIR occupancy, ambient light sensing, daylight harvesting, and environment monitoring for use within an Enlighted control network.	Provided with Advance sensor ready series 0-10V dimming drivers.
 PHILIPS EasySense	ES4	Set during commissioning	SNS211 MC	Bluetooth Wireless	Occupancy, daylight harvesting and task tuning sensor with advance grouping, for use within a MasterConnect network.	Provided with Advance sensor ready series 0-10V dimming drivers.
 CASAMBI	CA1	Set during commissioning	CBU-A2D	Bluetooth Wireless	0-10V/DALI driver controller, for use within a Casambi ecosystem.	For use with 0-10V or DALI drivers. Consult factory for details.
 nLIGHT	NL1	Set during commissioning	RES7 ²	Radio Wireless	Dimming, PIR occupancy detection and daylight harvesting, for use within an nLight AIR network.	Provided with Advance sensor ready series or eldoLED 0-10V drivers.
	NL2		RIO ²		Dimming, for use within an nLight AIR network.	
 LUTRON	LA1	Set during commissioning	A-WN-D01-RF-WH	Radio Wireless	Dimming only for use with an Athena control system.	Provided with Advance sensor ready series or eldoLED 0-10V or eldoLED DALI-2 drivers.
	LA2		A-WN-D01-OCC-WH		Dimming, PIR occupancy and daylight sensor for use with an Athena control system.	











1. Consult factory for custom light output setting.

2. Consult your Acuity representative for application-specific model number.

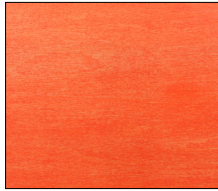
2" wide aperture LED luminaire with flush lens, wood or steel cladding

FINISH

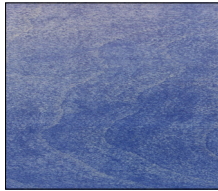
- All wood planks are hand selected from the top grades available, for minimal defects, with high consistency in grain, color and contrast. Being a natural material, some variances in these qualities are to be expected.
- Solid woods, bamboo ply and Baltic birch ply with natural maple are finished in five to seven coats of hand applied natural shellac, followed by a liquid wax sealer for easy cleaning.
- Stained Baltic birch plywood options are hand finished in multiple coats of semi-transparent stain, followed by a clear sealer.
- Corten steel cladding is finished in matte clear powder coat and includes button head fasteners in black finish. Due to the oxidizing nature of the material, variations in surface finish patina are to be expected.

	ORDERING CODE	DESCRIPTION		ORDERING CODE	DESCRIPTION
	WN	SOLID WALNUT		P01	BALTIC BIRCH PLY - NATURAL MAPLE
	EB	SOLID EUROPEAN BEECH		P02	BALTIC BIRCH PLY - RED STAINED MAPLE
	MH	SOLID MAHOGANY		P03	BALTIC BIRCH PLY - ORANGE STAINED MAPLE
	WO	SOLID WHITE OAK		P04	BALTIC BIRCH PLY - GREEN STAINED MAPLE
	BB	BAMBOO PLY		P05	BALTIC BIRCH PLY - BLUE STAINED MAPLE
	CS	CORTEN STEEL			

LENGTH/MOUNTING DIMENSIONS

ORDERING CODE	LENGTH A	LENGTH B
2	24-5/8"	16-5/8"
3	35-5/8"	27-5/8"
4	46-5/8"	38-5/8"
5	57-5/8"	49-5/8"
6	68-5/8"	60-5/8"
7	79-5/8"	71-5/8"
8	90-5/8"	82-5/8"

RUN CONFIGURATION INFORMATION

ORDERING CODE	DESCRIPTION
SN	Single

RUN INFORMATION

Plan - Wall Mount Single Fixture Option

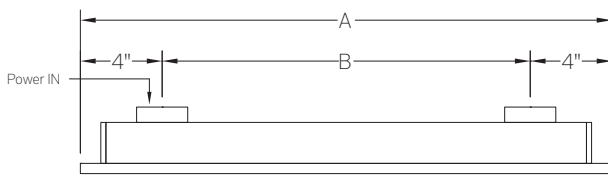

SN

Side View - Cable Mount Single Fixture Option

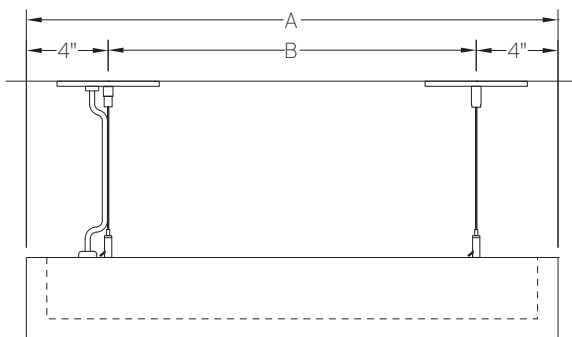

SN