

Project: _____ Type: _____

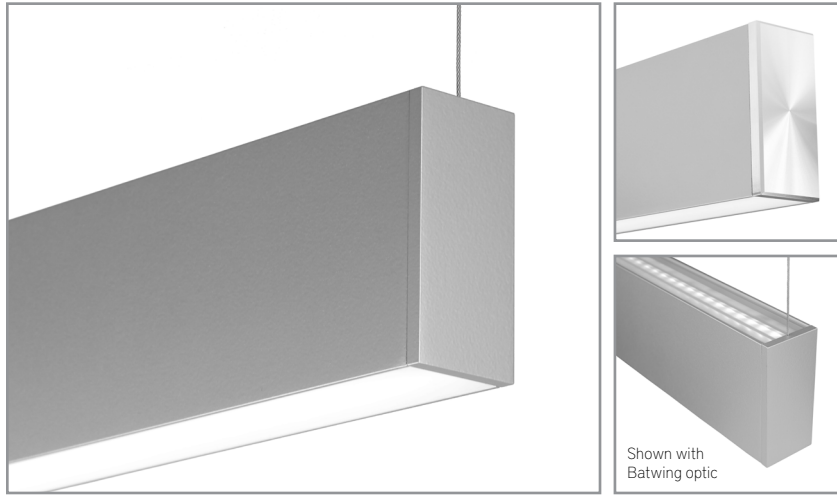

FEATURES

The Grom series GRM30 is a miniature, direct/indirect, linear luminaire for general lighting use. While small in profile, at 1-3/8" wide by 3" tall, the extruded aluminum fixture accepts a variety of popular drivers. Standard 90+ CRI LEDs, dual circuiting, multiple direct lens and indirect optic options enhance application versatility.

SPECIFICATIONS

Fixture constructed of an extruded aluminum housing, extruded acrylic lenses and machined aluminum end caps.

Fixture provided with minimal, small diameter aircraft cable and hardware.

Standard finishes as shown below.

Optional end cap with chamfered edges and lathe machined face available in mill aluminum finish.

Available in nominal lengths of 2'-8' single fixtures and continuous runs.

Standard integral 120-277V driver offered with 0-10V dimming or non-dim (other dimming driver options available).

Remote mounted emergency battery backup available (ordered separately, consult factory for details).

Available with Casambi wireless control.

Standard light outputs range from 470 to 640 lumens per foot, depending on optic option.

LEDs available in 2700K, 3000K, 3500K and 4000K, within a 3 step MacAdam ellipse, all with 90+ CRI typical.

Life: 50,000 hours L₇₀.

Limited five year warranty.

UL and UL-C listed for dry and damp locations.

SECTION

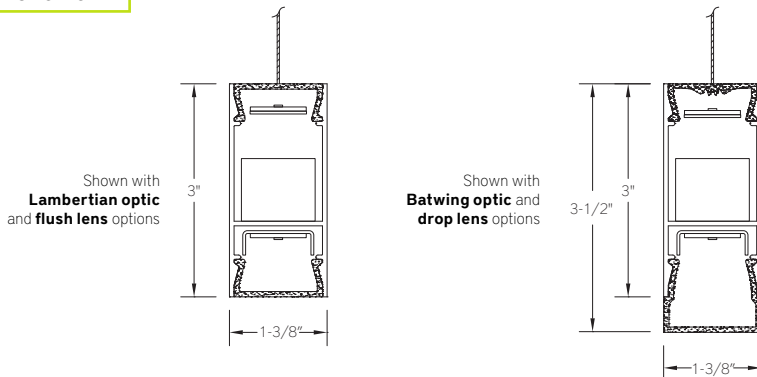

PERFORMANCE

Note: All data reflects fixtures with 3500K LEDs.

NOMINAL LENGTH	OPTIC CONFIGURATION	OUTPUT	LUMENS/ft.	WATTS/ft.	LUMINAIRE LUMENS	EFFICACY (LPW)
4'	Indirect - Lambertian	R: regular	500	3.9	2016	129
		H: high	640	5.1	2587	126
	Indirect - batwing	R: regular	550	5.1	2212	108
		H: high	640	6.0	2580	107

OPTIC CONFIGURATION	OUTPUT	LUMENS/ft.	WATTS/ft.	LUMINAIRE LUMENS	EFFICACY (LPW)
Direct - flush lens	R: regular	470	5.1	1898	93
	H: high	610	6.7	2460	91
Direct - drop lens, luminous ends	R: regular	485	5.1	1958	96
	H: high	630	6.7	2536	94



GRM30 -

NOMINAL FIXTURE LENGTH* 23: 22-5/8" 24: 24-1/8" 28: 28-1/8" 34: 33-5/8" 39: 39-1/8" 45: 44-5/8" 48: 48-1/8" 50: 50-1/8" 56: 55-5/8" 61: 61-1/8" 67: 66-5/8"	CORRELATED COLOR TEMPERATURE 72: 72-1/8" 78: 77-5/8" 83: 83-1/8" 89: 88-5/8" 96: 96-1/8"	DRIVER ND: non-dimming [Dimming] D: 0-10V, 1% DTR: triac, 1% DLV: electronic low voltage, 1% HES: Lutron EcoSystem, soft-on/fade-to-black, 1% EL: eldoLED ECOdrive 0-10V, 1% ES: eldoLED SOLOdrive 0-10V, 0.1% ELD: eldoLED ECOdrive DALI, 1% ESD: eldoLED SOLOdrive DALI, 0.1%	CIRCUIT 1: single circuit 2: two circuit (48" + length fixtures)	DIRECT LIGHT OUTPUT (lumens per foot w/ optic option C) R: regular - 485 H: high - 630	DIRECT OPTIC A: flush lens B: drop lens - solid end C: drop lens - luminous end	RUN CONFIGURATION SN: single ST: starter AD: adder TR: terminator	FINISH AW: architectural white (semi-matte) WH: white (semi-gloss) BL: black (semi-matte) MB: matte black ESS: environmental satin silver BR: bronze PR: primer CF: consult factory for custom finish
72: 72-1/8" 78: 77-5/8" 83: 83-1/8" 89: 88-5/8" 96: 96-1/8"	INDIRECT LIGHT OUTPUT (lumens per foot w/ optic option 1) R: regular - 500 H: high - 640	INDIRECT OPTIC 1: Lambertian 2: Batwing	MOUNT C4: cable mount 4' cable length C8: cable mount 8' cable length	OPTIONS LEC: lathe finish end cap** CA1: Casambi CBU-A2D ‡‡	RUN ‡	SA: satin anodize (may require additional lead time)	

* Actual dimension dependent on run configuration.

** End cap finish is mill aluminum. Powder coating or satin anodizing will conceal the fine machined surface detail.

‡ Specify run length to the nearest 1". Factory will configure using the least quantity of fixtures as close to the desired run length as possible.



Run to be confirmed with a shop drawing.

‡‡ See Integrated Controls section for driver compatibility information.

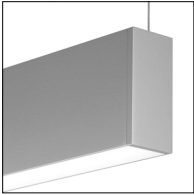
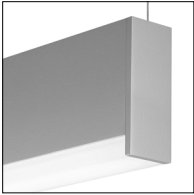
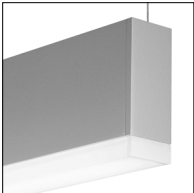
DIRECT OPTIC

	ORDERING CODE	DESCRIPTION	SPECIFICATIONS
	A	FLUSH LENS	Flush frosted acrylic extrusion
	B	DROP LENS - SOLID END	1/2" H frosted acrylic extrusion with full height aluminum end cap
	C	DROP LENS - LUMINOUS END	1/2" H frosted acrylic extrusion with matching acrylic end cap

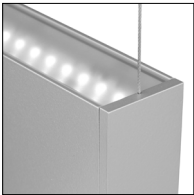
INDIRECT OPTIC

	ORDERING CODE	DESCRIPTION	SPECIFICATIONS
	1	LAMBERTIAN DISTRIBUTION	Clear extruded acrylic lens for general Lambertian distribution
	2	BATWING DISTRIBUTION	Clear extruded acrylic with wide distribution optic features

MOUNTING

	ORDERING CODE	DESCRIPTION
	C4 and C8	CABLE MOUNT Mounting option includes: <ul style="list-style-type: none"> • Ø 1/32" x 48" (C4) or 96" (C8) aircraft cables • 60" (C4) or 108" (C8) low voltage cable (in coordinating finish) • Bracket bars • Ø 5" white canopies • Canopy mount cable grippers

OPTIONS

	ORDERING CODE	DESCRIPTION	SPECIFICATIONS
	LEC	LATHE FINISH END CAP	<ul style="list-style-type: none"> • 1/4" thick machined aluminum end cap with chamfered edges and lathe finish face. • Finish is mill aluminum (Powder coating or satin anodizing will conceal the fine machined surface detail).

OPTIONS – INTEGRATED CONTROLS

Note: Control option takes up 4" of the overall lens length. For "A" optic option, controls are mounted to flush filler piece. For "B" and "C" optic option, controls are mounted to 1/2" H sheet formed cover.

	ORDERING CODE	LIGHT OUTPUT SETTING	MODEL	CONTROL PROTOCOL	FUNCTIONS	COMPATIBLE DRIVERS
CASAMBI	CA1	Set during commissioning	CBU-A2D	Bluetooth Wireless	0-10V/DALI driver controller, for use within a Casambi ecosystem.	For use with 0-10V or DALI drivers. Consult factory for details.

LENGTH/MOUNTING DIMENSIONS

ORDERING CODE	LENGTH A
23	22-1/4"
24	23-3/4"
28	27-3/4"
34	33-1/4"
39	38-3/4"
45	44-1/4"
48	47-3/4"
50	49-3/4"
56	55-1/4"
61	60-3/4"
67	66-1/4"
72	71-3/4"
78	77-1/4"
83	82-3/4"
89	88-1/4"
96	95-3/4"

RUN CONFIGURATION INFORMATION

ORDERING CODE	DESCRIPTION
SN	Single
ST	Starter
AD	Adder
TR	Terminator

RUN INFORMATION

Side View - Single Fixture

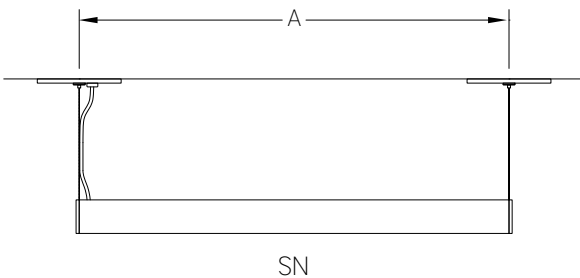

Side View - Continuous Run

