

Project: _____ Type: _____

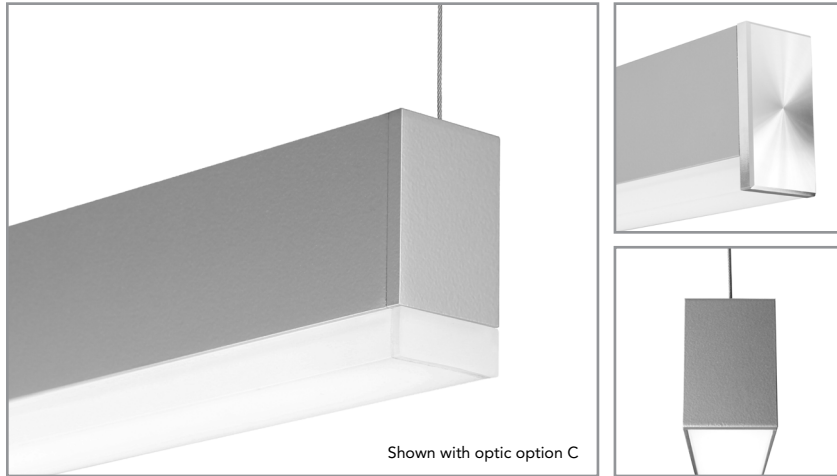

Shown with optic option C



Highlighted fields denote QuickShip Options. See complete 7-Day QuickShip Terms and Conditions available at www.bartcolighting.com/quickship-products/. Purchase order must reference "QuickShip".

FEATURES

The Grom series GRM20 is a miniature, linear architectural luminaire for general lighting use. The 1-3/8" wide by 2" tall extruded aluminum fixture is available for surface or cable mounting. An integral, miniature 0-10V dimming or non-dimming driver with multiple output options powers 90+ CRI LEDs. Extruded, frosted acrylic lenses are available in a flush and two drop profile options.

Fixture with certain options available for 7-Day QuickShip.

SPECIFICATIONS

Fixture constructed of an extruded aluminum housing, extruded acrylic lenses and 1/4" thick machined aluminum end caps

Model variations offered for surface and cable suspended applications

Standard finishes as shown below

Optional end cap with chamfered edges and lathe machined face available in mill aluminum finish

Available in nominal lengths of 2'-8' single fixtures and continuous runs

Standard integral 120-277V driver offered with 0-10V dimming or non-dim

Remote mounted emergency battery backup available (ordered separately, consult factory for details)

Standard light outputs range from 470 to 630 lumens per foot, depending on optic option

LEDs available in 2700K, 3000K, 3500K and 4000K, within a 3 step MacAdam ellipse, all with 90+ CRI typical

Life: 50,000 hours L₇₀

Limited five year warranty

UL and C-UL listed for dry and damp locations

SECTION

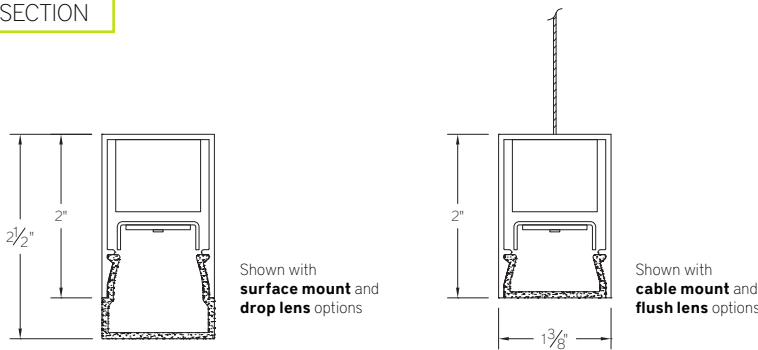

Shown with surface mount and drop lens options

Shown with cable mount and flush lens options

PERFORMANCE

Note: All data reflects fixtures with 3500K LEDs

| NOMINAL LENGTH | OPTIC CONFIGURATION | OUTPUT | LUMENS/ft. | WATTS/ft. | LUMINAIRE LUMENS | EFFICACY (LPW) |
|----------------|-----------------------------------|------------|------------|-----------|------------------|----------------|
| 4' | Direct - flush lens | R: regular | 470 | 5.1 | 1898 | 93 |
| | | H: high | 610 | 6.7 | 2460 | 91 |
| | Direct - drop lens, luminous ends | R: regular | 485 | 5.1 | 1958 | 96 |
| | | H: high | 630 | 6.7 | 2536 | 94 |



GRM20 -



| NOMINAL FIXTURE LENGTH* | CORRELATED COLOR TEMPERATURE | LIGHT OUTPUT (lumens per foot w/ optic option C) | OPTIC | MOUNT | RUN CONFIGURATION | FINISH |
|-------------------------|------------------------------|--|-----------------------------|---|-----------------------------|--|
| 23: 22-5/8" 61: 61-1/8" | 27: 2700K-90+ CRI | R: regular - 485 | A: flush lens | SM: surface mount | SN: single | AW: architectural white (semi-matte) |
| 24: 24-1/8" 67: 66-5/8" | 30: 3000K-90+ CRI | H: high - 630 | B: drop lens - solid end | C4: cable mount 4' cable length | ST: starter | WH: white (semi-gloss) |
| 28: 28-1/8" 72: 72-1/8" | 35: 3500K-90+ CRI | | C: drop lens - luminous end | C8: cable mount 8' cable length | AD: adder | BL: black (semi-matte) |
| 34: 33-5/8" 78: 77-5/8" | 40: 4000K-90+ CRI | | | CF: consult factory for custom mounting | TR: terminator | MB: matte black |
| 39: 39-1/8" 83: 83-1/8" | | | | | | ESS: environmental satin silver |
| 45: 44-5/8" 89: 88-5/8" | | | | | | BZ: bronze |
| 48: 48-1/8" 96: 96-1/8" | | | | | | PR: primer |
| 50: 50-1/8" RUN † | | | | | | CF: consult factory for custom finish |
| 56: 55-5/8" | | | | | | SA: satin anodize (may require additional lead time) |
| | | | | | OPTIONS | |
| | | | | | LEC: lathe finish end cap** | |

* Actual dimension dependent on run configuration.

** End cap finish is mill aluminum. Powder coating or satin anodizing will conceal the fine machined surface detail.

† Specify run length to the nearest 1". Factory will configure using the least quantity of fixtures as close to the desired run length as possible. Run to be confirmed with a shop drawing.

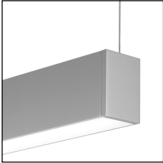
OPTIC

| | ORDERING CODE | DESCRIPTION | SPECIFICATIONS |
|---|---------------|--------------------------|--|
|  | A | FLUSH LENS | Flush frosted acrylic extrusion |
|  | B | DROP LENS - SOLID END | 1/2" H frosted acrylic extrusion with full height aluminum end cap |
|  | C | DROP LENS - LUMINOUS END | 1/2" H frosted acrylic extrusion with matching acrylic end cap |

MOUNTING

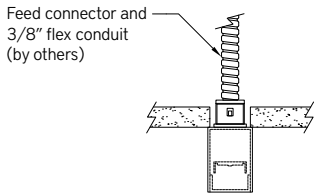
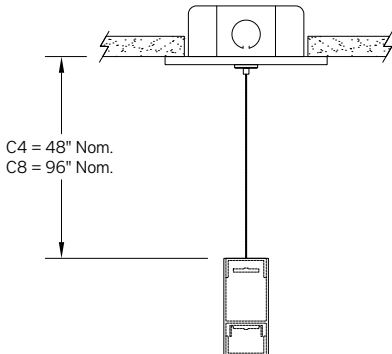
| | ORDERING CODE | DESCRIPTION |
|---|---------------|--|
|  <p>Feed connector and 3/8" flex conduit (by others)</p> | SM | SURFACE MOUNT Use appropriate fastener through Ø3/16" holes in housing. Single (SN) and Starter (ST) fixtures provided with Ø7/8" feed hole for use with snap-in style electrical connectors (by others) |
|  <p>C4 = 48" Nom. C8 = 96" Nom.</p> | C4 and C8 | CABLE MOUNT Mounting option includes: <ul style="list-style-type: none"> • Ø 1/32" x 48" (C4) or 96" (C8) aircraft cables • 60" (C4) or 108" (C8) low voltage cable (in coordinating finish) • Bracket bars • Ø 5" white canopies • Canopy mount cable grippers |

OPTIONS

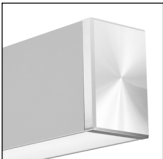
| | ORDERING CODE | DESCRIPTION | SPECIFICATIONS |
|---|---------------|----------------------|--|
|  | LEC | LATHE FINISH END CAP | <ul style="list-style-type: none"> • 1/4" thick machined aluminum end cap with chamfered edges and lathe finish face • Finish is mill aluminum (Powder coating or satin anodizing will conceal the fine machined surface detail) |

LENGTH/MOUNTING DIMENSIONS

| ORDERING CODE | LENGTH A | LENGTH B | LENGTH C |
|---------------|----------|-----------|----------|
| 23 | 22-5/8" | 22-7/16" | 22-1/4" |
| 24 | 24-1/8" | 23-15/16" | 23-3/4" |
| 28 | 28-1/8" | 27-15/16" | 27-3/4" |
| 34 | 33-5/8" | 33-7/16" | 33-1/4" |
| 39 | 39-1/8" | 39-15/16" | 38-3/4" |
| 45 | 44-5/8" | 44-7/16" | 44-1/4" |
| 48 | 48-1/8" | 47-15/16" | 47-3/4" |
| 50 | 50-1/8" | 49-15/16" | 49-3/4" |
| 56 | 55-5/8" | 55-7/16" | 55-1/4" |
| 61 | 61-1/8" | 90-15/16" | 60-3/4" |
| 67 | 66-5/8" | 66-7/16" | 66-1/4" |
| 72 | 72-1/8" | 71-15/16" | 71-3/4" |
| 78 | 77-5/8" | 77-7/16" | 77-1/4" |
| 83 | 83-1/8" | 82-15/16" | 82-3/4" |
| 89 | 88-5/8" | 88-7/16" | 88-1/4" |
| 96 | 96-1/8" | 95-15/16" | 95-3/4" |

RUN CONFIGURATION INFORMATION

| ORDERING CODE | DESCRIPTION |
|---------------|-------------|
| SN | Single |
| ST | Starter |
| AD | Adder |
| TR | Terminator |

RUN INFORMATION

Back Plan - Surface Mount Single Fixture

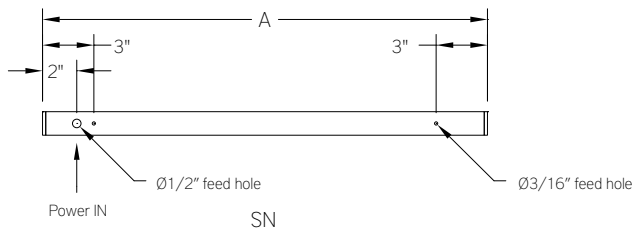

Back Plan - Surface Mount Continuous Run

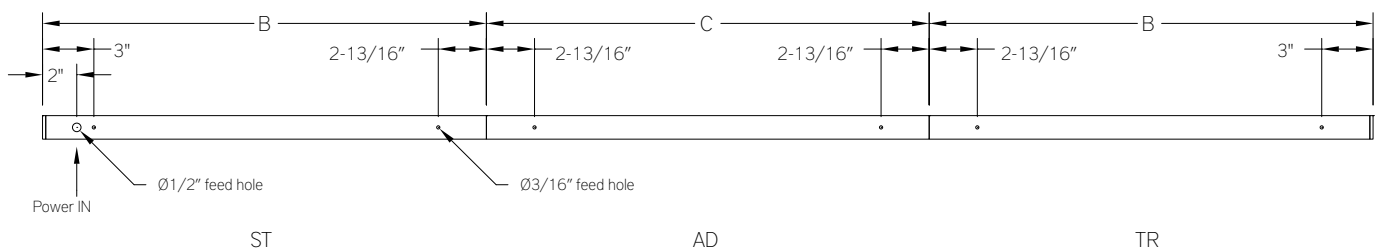

RUN INFORMATION

Side View - Single Fixture

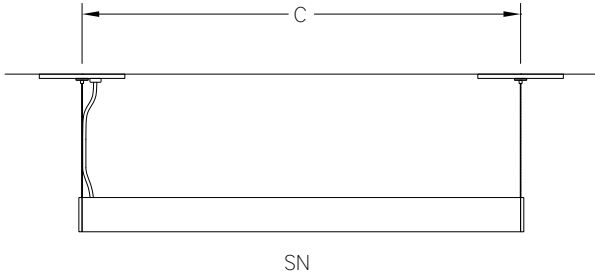

Side View - Continuous Run

